

Product information

0985 342 100/...M - 0985 342 100/2 M

Industrial Connecting Solutions:I/O Modules:I/O Modules Activ - Stand Alone:Industrial Ethernet:Accessories:Industrial Ethernet Data Cables:Overmolded Double Ended Cordsets:0985 342 100/...M

https://www.e-catalog.beldensolutions.com:443/link/57078-24228-255441-219791-247858-277551-252859-277359-277456/en/0985_342_100_0200/uistate

Name	0985 342 100/...M
	
	Cord set, double-ended, M12-M12, Industrial Ethernet Data cable according to ProfiNet type C, molded on both sides with M12 male connectors, D coded according to IEC 61076-2-101, 4 poles, PUR jacket, halogen-free, shielded, green, 2 meter.
Delivery informations	
Availability	available
Product description	
Type	0985 342 100/2 M
Order No.	64367
Description	Cord set, double-ended, M12-M12, Industrial Ethernet Data cable according to ProfiNet type C, molded on both sides with M12 male connectors, D coded according to IEC 61076-2-101, 4 poles, PUR jacket, halogen-free, shielded, green, 2 meter.
Note	The application of these products in harsh environments should always be checked before use.
Color of housing	black
Number of contacts	4
Product characteristics	Oil resistance
Classification	
Belden class	Industrial Ethernet Data Cables
Belden brand	Lumberg-Automation
Mechanical data	
Type of plug-in contact	Male connector
Type of plug-in contact, side 2	Male connector
Design of housing	straight
Design of housing, side 2	straight
Thread	M12
Coding of the M12 round plug connector	D
Environmental conditions	
Environmental temperature	-25 °C ... 80 °C
Environmental temperature (explanation)	Derating to be observed
Degree of protection (IP), mounted	IP67
Pollution degree	3
Materials	
Housing material / Molded body	TPU
Contact bearer material	TPU
Contact material	CuSn
Contact material - Surface refinement	gold-plated
Knurled screw / nut material	CuZn, nickel-plated
Shield sleeve material	CuZn, tined
Approvals	
RoHS 2002/95/EG compliant	yes
Electrical data	
Contact resistance	≤ 5 mΩ
Rated current In	4 A at 40°C, Derating to be observed
Nominal voltage	60 V
Rated voltage	250 V
Test voltage	2.5 kV eff./60 s
Insulation resistance	> 1 GΩ

Industrial Connecting Solutions:I/O Modules:I/O Modules Activ - Stand Alone:Industrial Ethernet:Accessories:Industrial Ethernet Data Cables:Overmolded Double Ended Cordsets:0985 342 100/...M
https://www.e-catalog.beldensolutions.com:443/link/57078-24228-255441-219791-247858-277551-252859-277359-277456/en/0985_342_100_0200/uistate

Cable	
Cable length	2 m
Cable number	342
Cable description	Bus cable Industrial Ethernet, ProfiNet type C standard
Color of jacket	green
Material of outer jacket	PUR
Without halogens as in EN 50267-2-3	✓
shielded	✓
welding spark proof	✗
Outer diameter of the cable	6.2 mm
Number of conductors	4
Cable design	4 x 0.38 mm ² (AWG 22)
Conductor design	19 x Ø 0.16 mm

Picture

Drawing

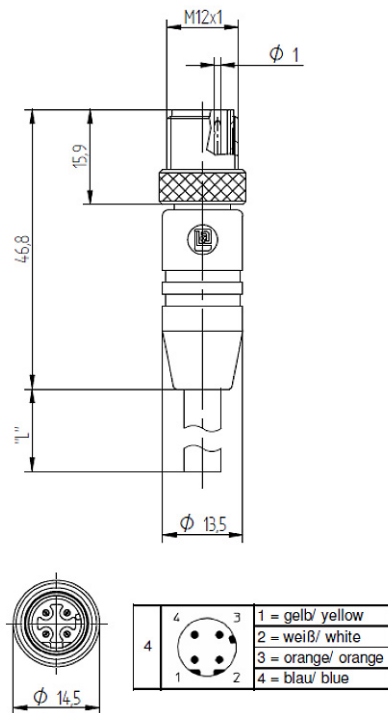

Belden Deutschland GmbH
 Im Gewerbepark 2
 58579 Schalksmühle
 Germany
 Phone: +49 7127/14-1806
 E-Mail: icos-sales@belden.com

The information published in the websites has been compiled as carefully as possible. It is subject to alteration without notice in technical as well as in price-related/commercial respect. The complete information and data were available on user documentation. Mandatory information can only be obtained by a concrete query.