



Single-Ended Overmolded M12 Cordset for Actuators and Sensors – Standard Male Connectors



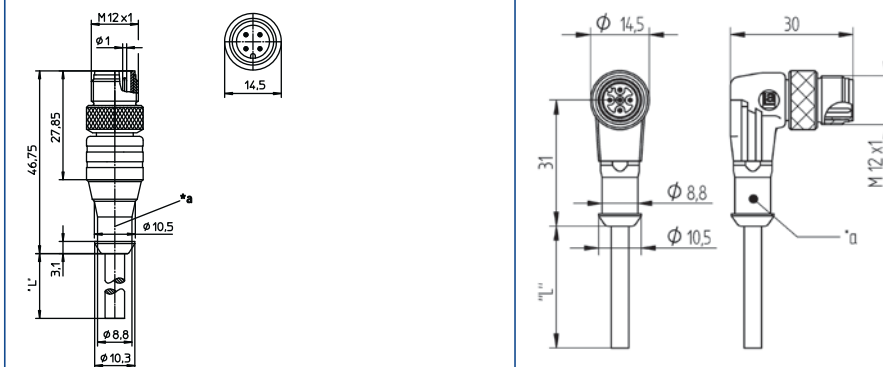

Technical Information

Product Description		
Order Designation	RST	RSWT
		
Description	Actuator/sensor cordset, M12 overmolded male connector, straight, with self-locking screw coupling	Actuator/sensor cordset, M12 overmolded male connector, angled, with self-locking screw coupling
RoHS-compliant (2011/65/EU)	Yes	
(Construction Type) Standard	IEC 61076-2-101	
Approvals	UL	
Technical Data		
Ambient Temperature	-40 °C to +90 °C, mind cable temperature range	
Housing Material/Grip	TPU	
Contact Holder Material	TPU	
Contact Material/Surface Finish	CuSn, gold over nickel plating	
Screw Coupling Material	CuZn, nickel-plated	
Mechanical Data		
Degree of Protection	IP67, IP68 (only when mated to associated counterparts)	
Electrical Data		
Contact Resistance	≤ 5 mΩ	
Rated Voltage	3 to 4-pin 250 V, 5-pin 60 V, 8-pin 30 V	
Rated Current	3 and 5-pin 4 A, 8-pin 2 A	
Pollution Degree	3	
Technical Drawing		















*a = Protective sleeve assembly • L = Standard length of cable

Pin Assignment



























































































3-pin	4-pin	5-pin	8-pin
 <p>1 = brown 3 = blue 4 = black</p> <p>Contact 1 leading</p>	 <p>1 = brown 2 = white 3 = blue 4 = black</p>	 <p>1 = brown 2 = white 3 = blue 4 = black 5 = green/yellow</p> <p>Contact 5 leading</p>	 <p>1 = white 2 = brown 3 = green 4 = yellow 5 = gray 6 = pink 7 = blue 8 = shield</p>

Order Information





























































































Order No.	Order Designation	No. of Pins	Jacket	Characteristics
11719	RST 3-06/2 M	3	PVC, orange	 
11720	RST 3-06/5 M	3	PVC, orange	 
11718	RST 3-06/10 M	3	PVC, orange	 
43703	RST 3-224/2 M	3	PUR, halogen-free, black	   
43704	RST 3-224/5 M	3	PUR, halogen-free, black	   
43702	RST 3-224/10 M	3	PUR, halogen-free, black	   
41731	RST 3-260/2 M	3	PUR, halogen-free, orange	    
71255	RST 3-260/5 M	3	PUR, halogen-free, orange	    
71266	RST 3-260/10 M	3	PUR, halogen-free, orange	    
9835	RST 3-294/2 M	3	PVC, black	 
3148	RST 3-294/5 M	3	PVC, black	 
3149	RST 3-294/10 M	3	PVC, black	 
11804	RST 4-07/2 M	4	PVC, orange	 
11805	RST 4-07/5 M	4	PVC, orange	 
11803	RST 4-07/10 M	4	PVC, orange	 
11809	RST 4-225/2 M	4	PUR, halogen-free, black	   
11810	RST 4-225/5 M	4	PUR, halogen-free, black	   
29618	RST 4-225/10 M	4	PUR, halogen-free, black	   
11811	RST 4-251/2 M	4	PUR, halogen-free, orange	    
11812	RST 4-251/5 M	4	PUR, halogen-free, orange	    
46902	RST 4-251/10 M	4	PUR, halogen-free, orange	    
91332	RST 4-265/2 M	4	PUR, halogen-free, gray	  
51939	RST 4-265/5 M	4	PUR, halogen-free, gray	  
81994	RST 4-265/10 M	4	PUR, halogen-free, gray	  

Single-Ended Overmolded M12 Cordset for Actuators and Sensors – Standard Male Connectors *(continued)*

Order Information

Order No.	Order Designation	No. of Pins	Jacket	Characteristics
693	RST 4-500/2 M	4	PUR, halogen-free, black	      
694	RST 4-500/5 M	4	PUR, halogen-free, black	      
695	RST 4-500/10 M	4	PUR, halogen-free, black	      
46615	RST 4-602/2 M	4	TPE, yellow	
26875	RST 4-602/5 M	4	TPE, yellow	
55304	RST 4-602/10 M	4	TPE, yellow	
12016	RST 5-56/2 M	5	PVC, orange	 
12017	RST 5-56/5 M	5	PVC, orange	 
12015	RST 5-56/10 M	5	PVC, orange	 
10436	RST 5-72/2 M	5	PUR, black	  
15274	RST 5-72/5 M	5	PUR, black	  
107305	RST 5-72/10 M	5	PUR, black	  
15792	RST 5-87/2 M	5	PUR, black	 
15794	RST 5-87/5 M	5	PUR, black	 
15795	RST 5-87/10 M	5	PUR, black	 
11890	RST 5-228/2 M	5	PUR, halogen-free, black	   
11891	RST 5-228/5 M	5	PUR, halogen-free, black	   
17061	RST 5-228/10 M	5	PUR, halogen-free, black	   
11895	RST 5-259/2 M	5	PUR, halogen-free, orange	    
11896	RST 5-259/5 M	5	PUR, halogen-free, orange	    
47018	RST 5-259/10 M	5	PUR, halogen-free, orange	    
51495	RST 5-289/2 M	5	PVC, black	 
51496	RST 5-289/5 M	5	PVC, black	 
51497	RST 5-289/10 M	5	PVC, black	 
10435	RST 5-296/2 M	5	PVC, black	 
934637790	RST 5-296/5 M	5	PVC, black	 
1222	RST 5-296/10 M	5	PVC, black	 
12084	RST 8-09/2 M	8	PUR, orange	 
12085	RST 8-09/5 M	8	PUR, orange	 
12083	RST 8-09/10 M	8	PUR, orange	 

Order Information

Order No.	Order Designation	No. of Pins	Jacket	Characteristics
47076	RST 8-282/2 M	8	PUR, halogen-free, black	   
64545	RST 8-282/5 M	8	PUR, halogen-free, black	   
64544	RST 8-282/10 M	8	PUR, halogen-free, black	   
97324	RST 8-344/2 M	8	PUR, halogen-free, black	  
97325	RST 8-344/5 M	8	PUR, halogen-free, black	  
108754	RST 8-344/10 M	8	PUR, halogen-free, black	  
9838	RST 12-346/2 M	12	PUR, halogen-free, black	  
105423	RST 12-346/5 M	12	PUR, halogen-free, black	  
934637041	RST 12-346/10 M	12	PUR, halogen-free, black	  
12106	RSWT 3-06/2 M	3	PVC, orange	 
12107	RSWT 3-06/5 M	3	PVC, orange	 
8816	RSWT 3-06/10 M	3	PVC, orange	 
934636133	RSWT 3-224/2 M	3	PUR, halogen-free, black	   
70397	RSWT 3-224/5 M	3	PUR, halogen-free, black	   
1028	RSWT 3-224/10 M	3	PUR, halogen-free, black	   
12112	RSWT 4-07/2 M	4	PVC, orange	 
12113	RSWT 4-07/5 M	4	PVC, orange	 
12111	RSWT 4-07/10 M	4	PVC, orange	 
46523	RSWT 4-225/2 M	4	PUR, halogen-free, black	   
44597	RSWT 4-225/5 M	4	PUR, halogen-free, black	   
46629	RSWT 4-225/10 M	4	PUR, halogen-free, black	   
934636116	RSWT 5-56/2 M	5	PVC, orange	 
9859	RSWT 5-56/5 M	5	PVC, orange	 
9870	RSWT 5-56/10 M	5	PVC, orange	 
44782	RSWT 5-228/2 M	5	PUR, halogen-free, black	   
50527	RSWT 5-228/5 M	5	PUR, halogen-free, black	   
58489	RSWT 5-228/10 M	5	PUR, halogen-free, black	   
15951	RSWT 8-09/2 M	8	PUR, orange	   
9882	RSWT 8-09/5 M	8	PUR, orange	   
934637356	RSWT 8-09/10 M	8	PUR, orange	