

## M12-Round-Plug Connector, Single-Ended Cordsets, According to IEC 61076-2-101

RKTS | RKWTH



### 4-, 5-, and 8-Poles (Shielded)

Actuator/sensor cordset, single-ended, M12, 4-, 5-, and 8-poles, female straight connector, internal threads with threaded joint and molded cable, shielding connecting to knurled nut.

RKTS

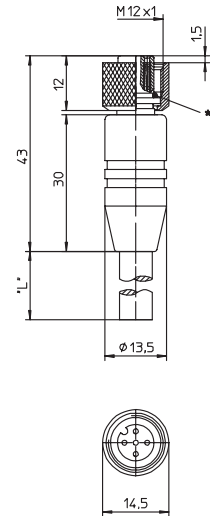

Actuator/sensor cordset, single-ended, M12, 4-, 5-, and 8-poles, female 90° connector, internal threads with threaded joint and molded cable, shielding connecting to knurled nut.

RKWTH

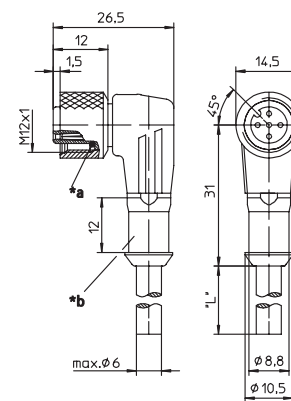

### Pin Assignments

#### M12 - Female

##### 4 poles

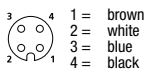

##### 5 poles

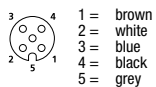

##### 8 poles

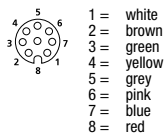



## M12-Round-Plug Connector, Single-Ended Cordsets, According to IEC 61076-2-101 RKTS | RKWTH

### Technical Data

#### Environmental

Degree of protection IP 67 / NEMA 6P  
Operating temperature range -25°C (-13°F) / +80°C (+176°F)

#### Mechanical

Housing / Molded body TPU  
Insert TPU  
Contact CuSn, pre-nickelated and 0.8 microns gold-plated  
Coupling nut CuZn, nickel-plated  
Shield sleeve CuZn, nickel-plated  
O-ring FKM

#### Electrical









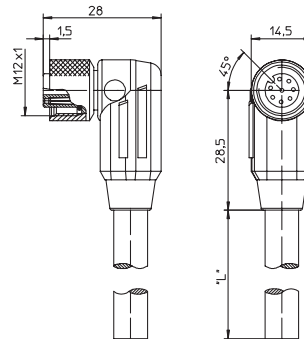





Contact resistance ≤ 5 mΩ  
Nominal current at 40°C 4 A  
Nominal voltage 4 poles 240 V  
5 poles 60 V  
8 poles 30 V  
Rated voltage 3-4 poles 250 V  
5 poles 63 V  
8 poles 36 V  
Test voltage 3-4 poles 2.0 kV eff. / 60 s  
5-8 poles 1.5 kV eff. / 60 s  
Insulation resistance > 10<sup>9</sup> Ω

### Cable Specifications

| Cable No. | Outer Jacket                | Conductor Size           | Jacket Color | OD             |
|-----------|-----------------------------|--------------------------|--------------|----------------|
| 182       | PVC, shielded               | 4 x 0.34 mm <sup>2</sup> | Orange       | .217" (5.5 mm) |
| 183       | PVC, shielded               | 5 x 0.34 mm <sup>2</sup> | Orange       | .236" (6.0 mm) |
| 184       | PVC, shielded               | 8 x 0.25 mm <sup>2</sup> | Orange       | .260" (6.6 mm) |
| 288       | PUR, halogen-free, shielded | 4 x 0.34 mm <sup>2</sup> | Black        | .217" (5.5 mm) |
| 298       | PUR, halogen-free, shielded | 5 x 0.34 mm <sup>2</sup> | Black        | .236" (6.0 mm) |
| 299       | PUR, halogen-free, shielded | 8 x 0.25 mm <sup>2</sup> | Black        | .260" (6.6 mm) |

### RKWTH (8-pole version)



| Part Number            | Pins              | Outer Jacket | Standard Cable Lengths | Characteristics  |   |
|------------------------|-------------------|--------------|------------------------|------------------|---|
| <b>Female Straight</b> | <b>Female 90°</b> |              |                        |                  |   |
| RKTS 4-182/...M        | RKWTH 4-182/...M  | 4            | PVC                    | 2 M / 5 M / 10 M |    |
| RKTS 4-288/...M        | RKWTH 4-288/...M  |              | PUR, halogen-free      | 2 M / 5 M / 10 M |     |
| RKTS 5-183/...M        |                   | 5            | PVC                    | 2 M / 5 M / 10 M |    |
| RKTS 5-298/...M        | RKWTH 5-298/...M  |              | PUR, halogen-free      | 2 M / 5 M / 10 M |     |
| RKTS 8-184/...M        |                   | 8            | PVC                    | 2 M / 5 M / 10 M |    |
| RKTS 8-299/...M        | RKWTH 8-299/...M  |              | PUR, halogen-free      | 2 M / 5 M / 10 M |     |